

NOTE 1: SOME SYSTEMS (eg. CROMEMCO, NORTHSTAR) USE PIN 53 AS DATA DISABLE FOR THESE SYSTEMS, CUT TRACE FROM PIN 53.

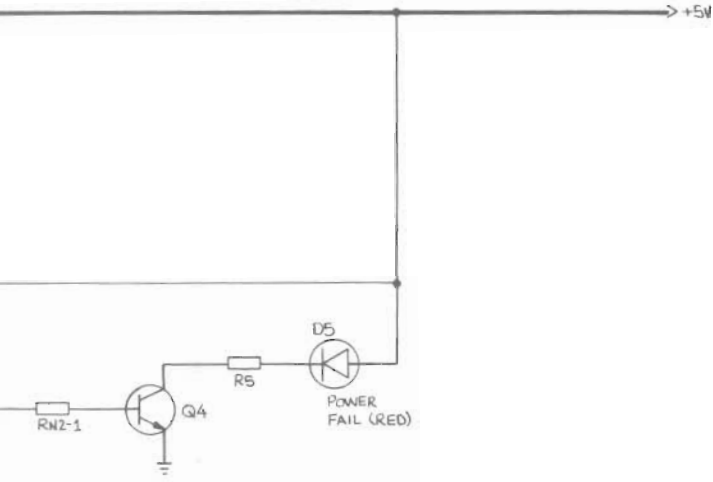

→ LATCHED PWR FAIL  
2/4D  
3/3H

→ POWER FAIL  
1/6F

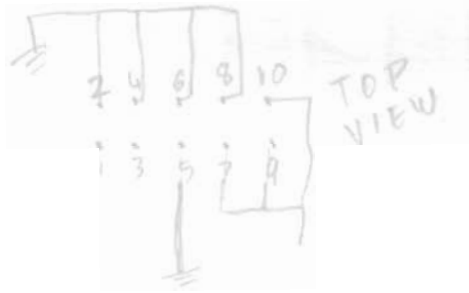
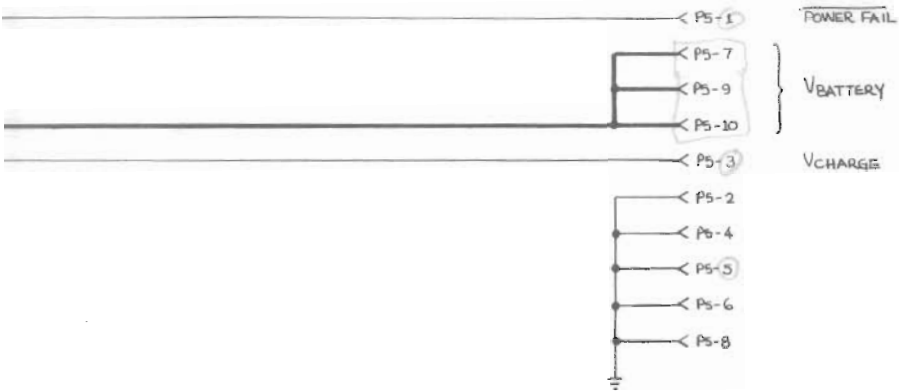

DO NOT SCALE TO DRAWING

REV	ZONE	DESCRIPTION	DATE	APP
MODEL		QUASI-DISK	DWG DE-900006-	
DESC		SEMICONDUCTOR DISK	REV-CO	
SCALE	NONE	SHT 5 OF 5	DWN BPZ	
CKD		APP RPH	DATE 11/07/83	



F E D C B A

L | K | J | H | G | F

1  
2  
3  
4  
5  
6  
7

DO 0  
DI 0  
DO 1  
DI 1  
DO 2  
DI 2  
DO 3  
DI 3  
  
DO 4  
DI 4  
DO 5  
DI 5  
DO 6  
DI 6  
DO 7  
DI 7  
  
A15  
A14  
A13  
A12  
A11  
A10  
A9  
A8  
  
A7  
A6  
A5  
A4  
A3  
  
RESET  
SOUT  
SINP  
PWR  
PDBIN  
SLAVE CLR  
A2  
A1  
A0  
RDY  
XRDY

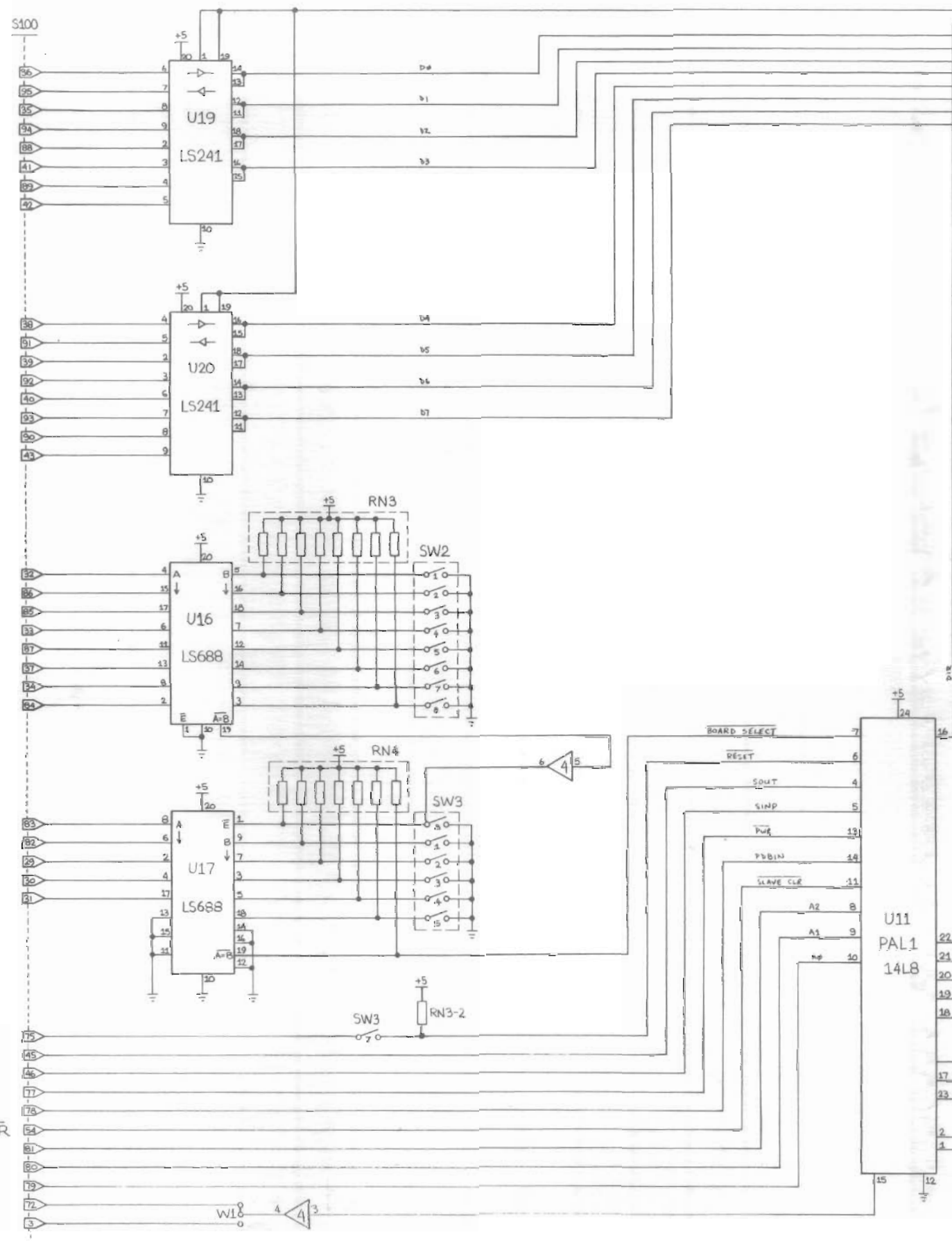

L | K | J | H | G | F

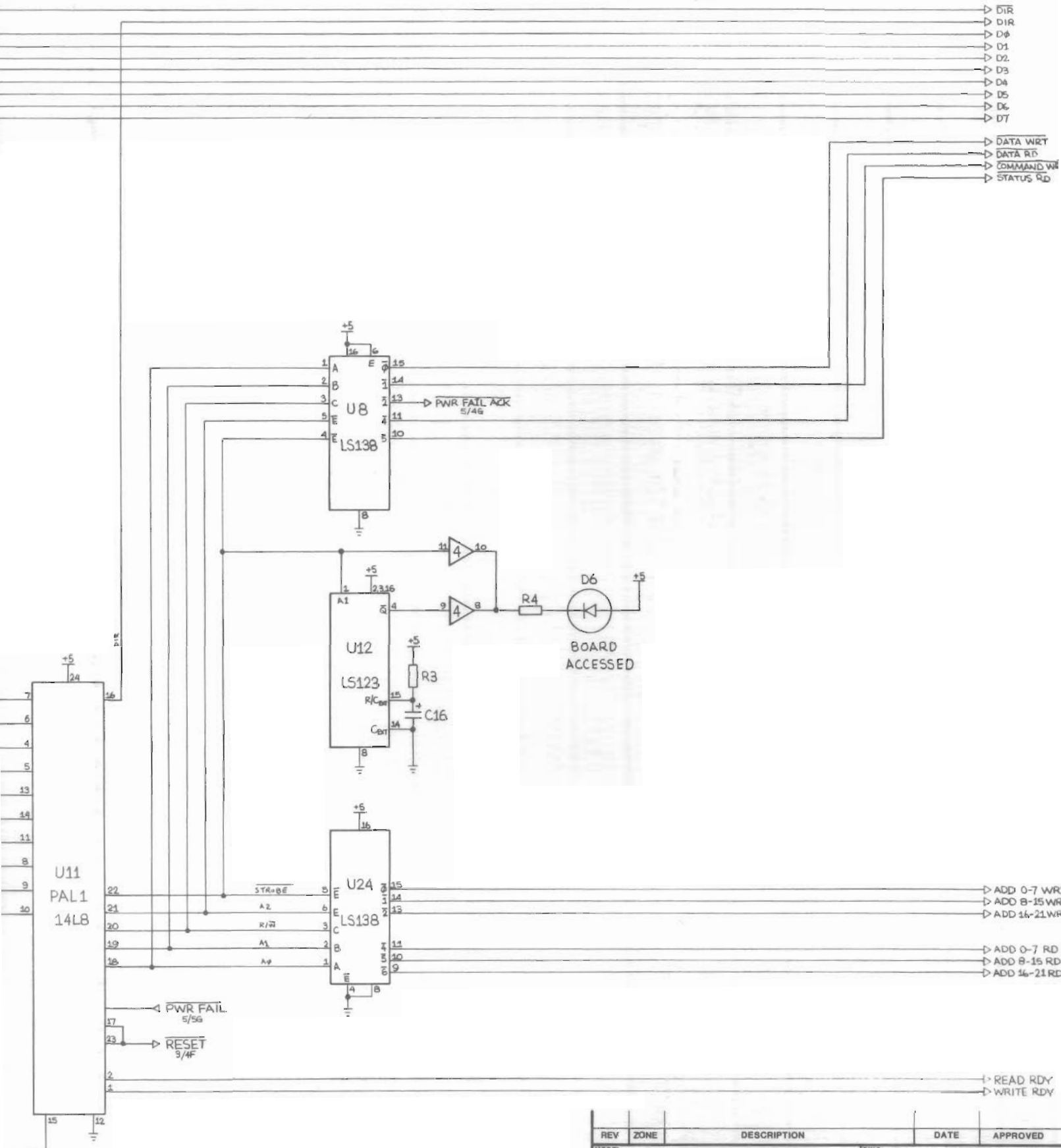

DO NOT SCALE TO DRAWING

REV	ZONE	DESCRIPTION	DATE	APPROVED
MODEL		QUASI-DISK	DWG DE-900006-00	
DESC		SEMICONDUCTOR DISK	REV-C00	
SCALE	NONE	SHY 1 OF 5	DWN BPZ	
CKD		APP RPH	DATE 11/07/83	

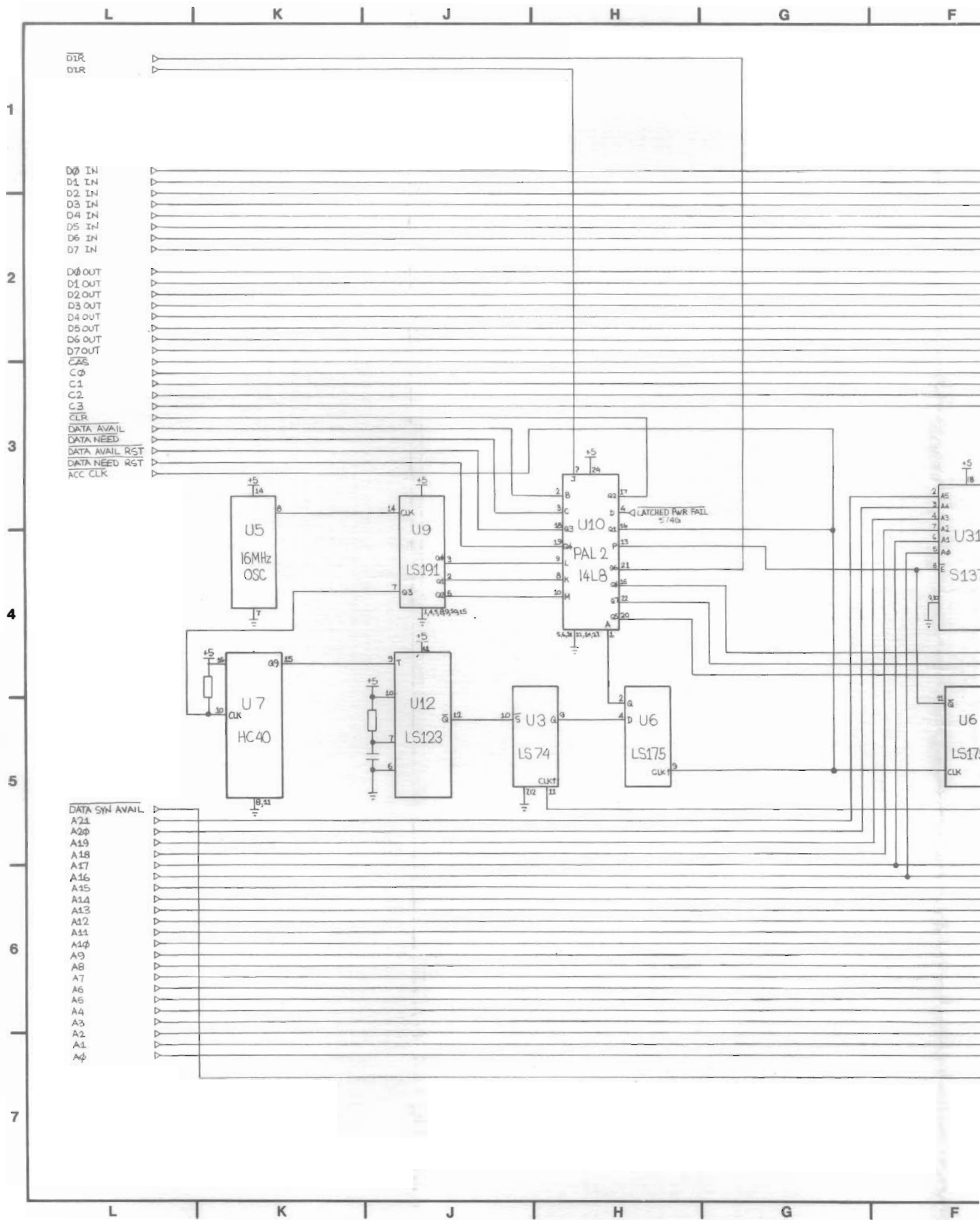

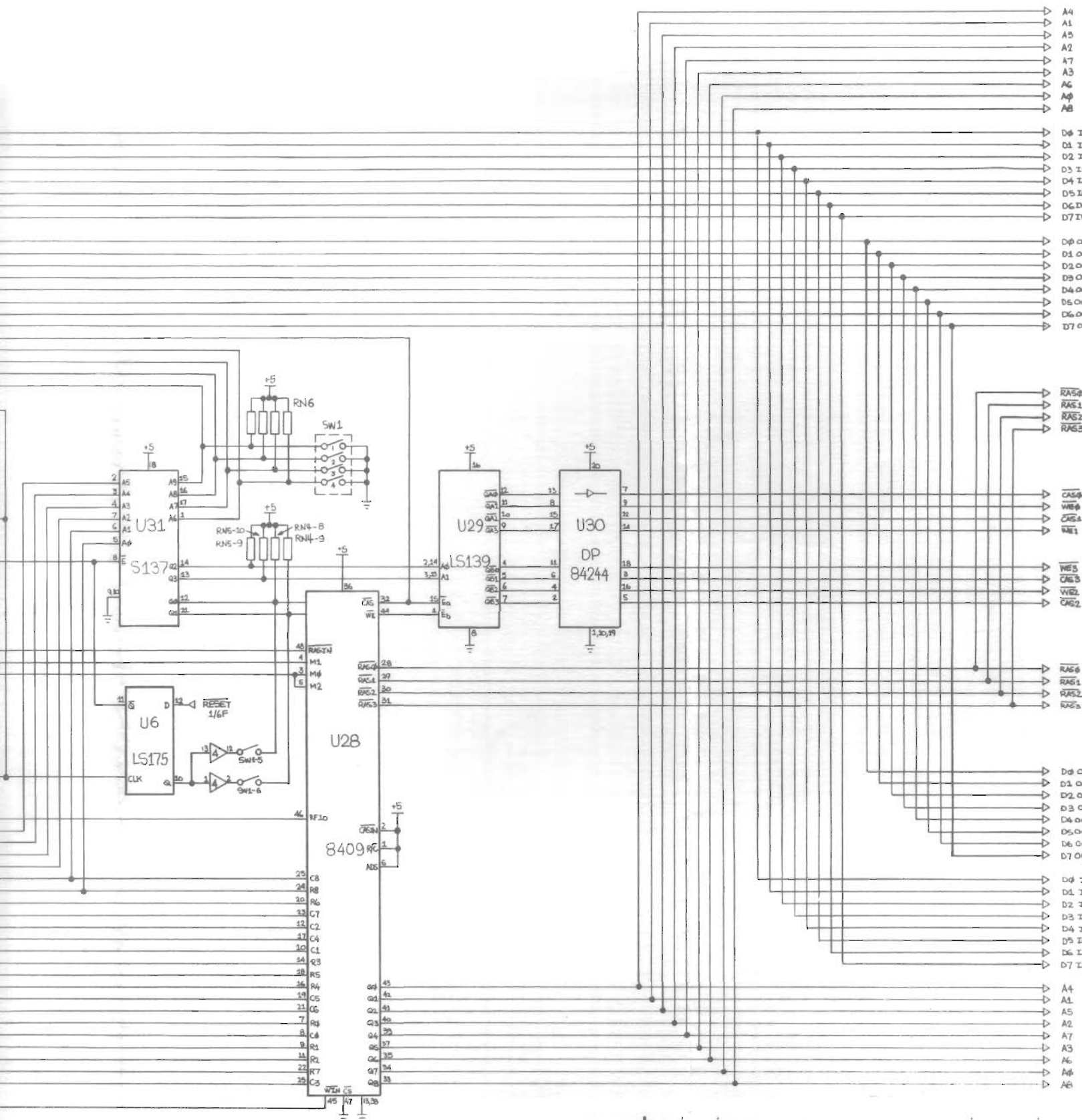

DO NOT SCALE TO DRAWING

REV	ZONE	DESCRIPTION	DATE	APPRO
MODEL		QUASI-DISK	DWG DE-900006-0	
DESC		SEMICONDUCTOR DISK	REV-C00	
SCALE	NONE	SHT 3 OF 5	DWN BPZ	
CKD	APP RPH	DATE 11/07/83		



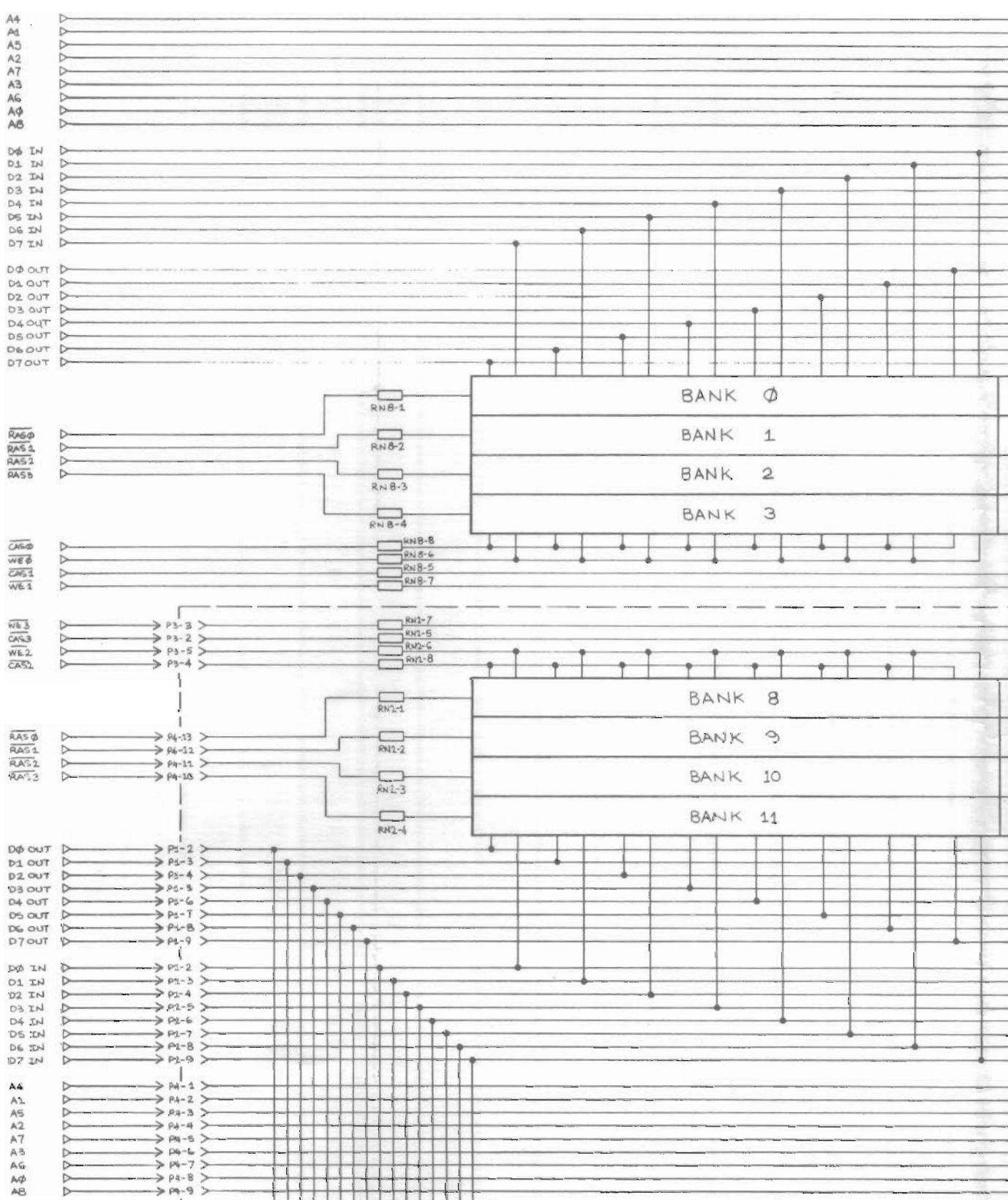

**Expansion Module**

NOTE: P1-1, P2-1, P3-1 = +5V  
 P1-10, P2-10, P3-6 = GND.

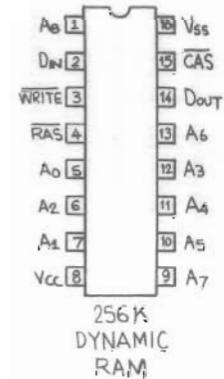
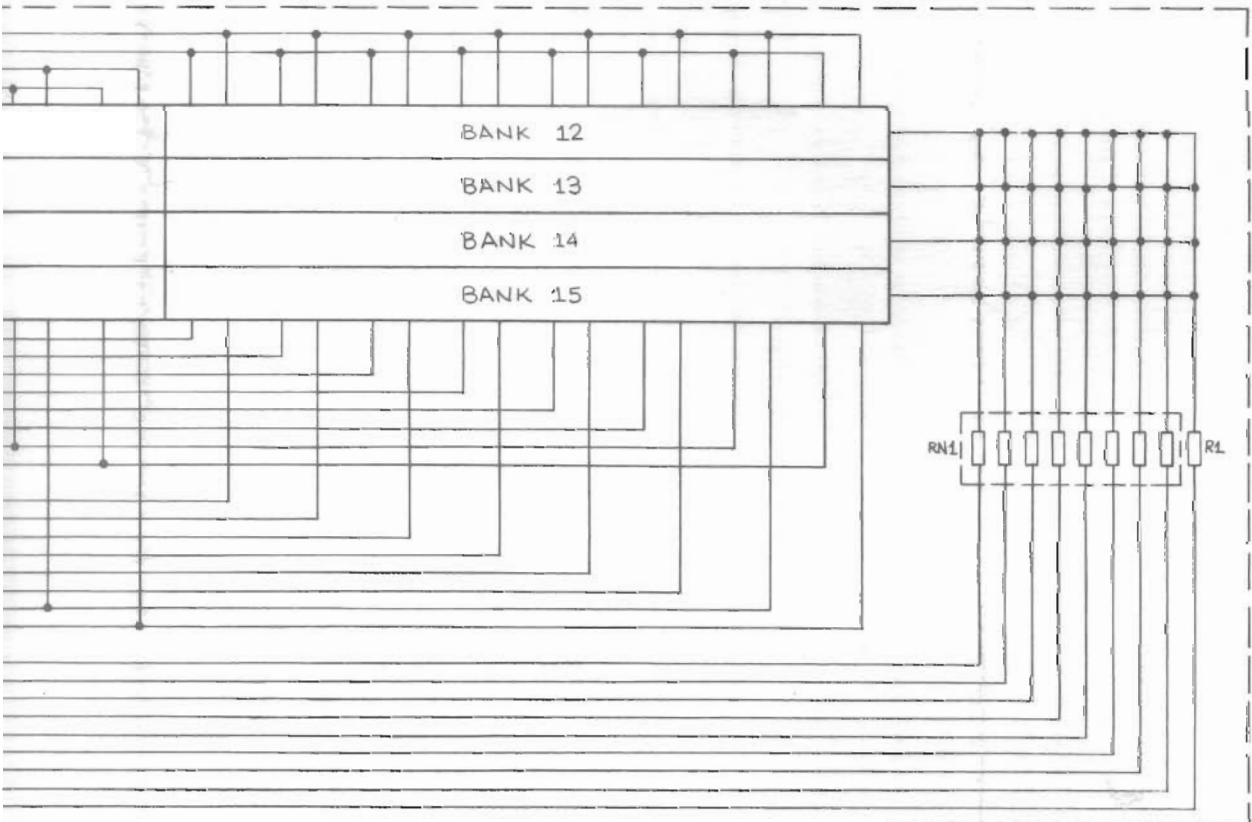
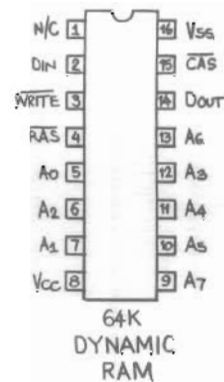
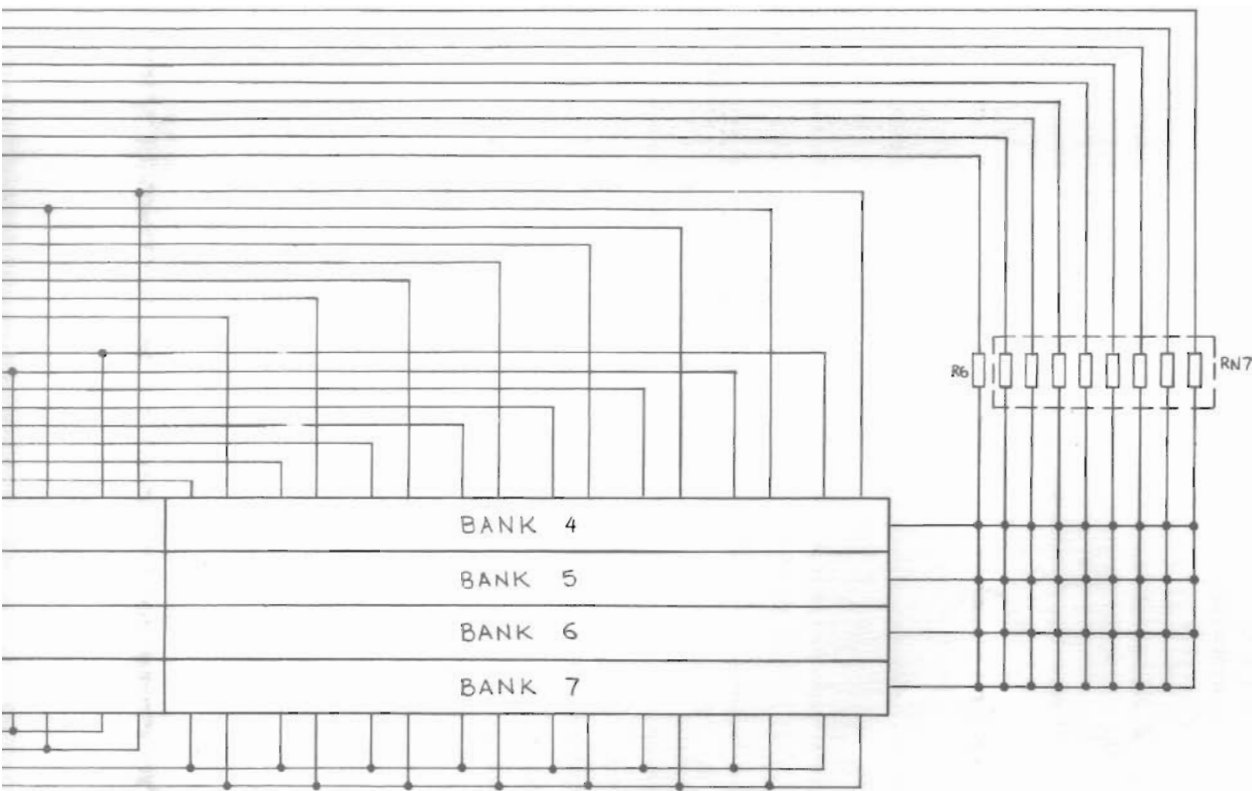

Module

DO NOT SCALE TO DRAWING

REV	ZONE	DESCRIPTION	DATE	APPROVED
MODEL		QUASI-DISK	DWG DE-900006-00	
DESC		SEMICONDUCTOR DISK	REV-C00	
SCALE	NONE	SHT 4 OF 5	DWN BPZ	
CKD		APP RPH	DATE 11/07/83	





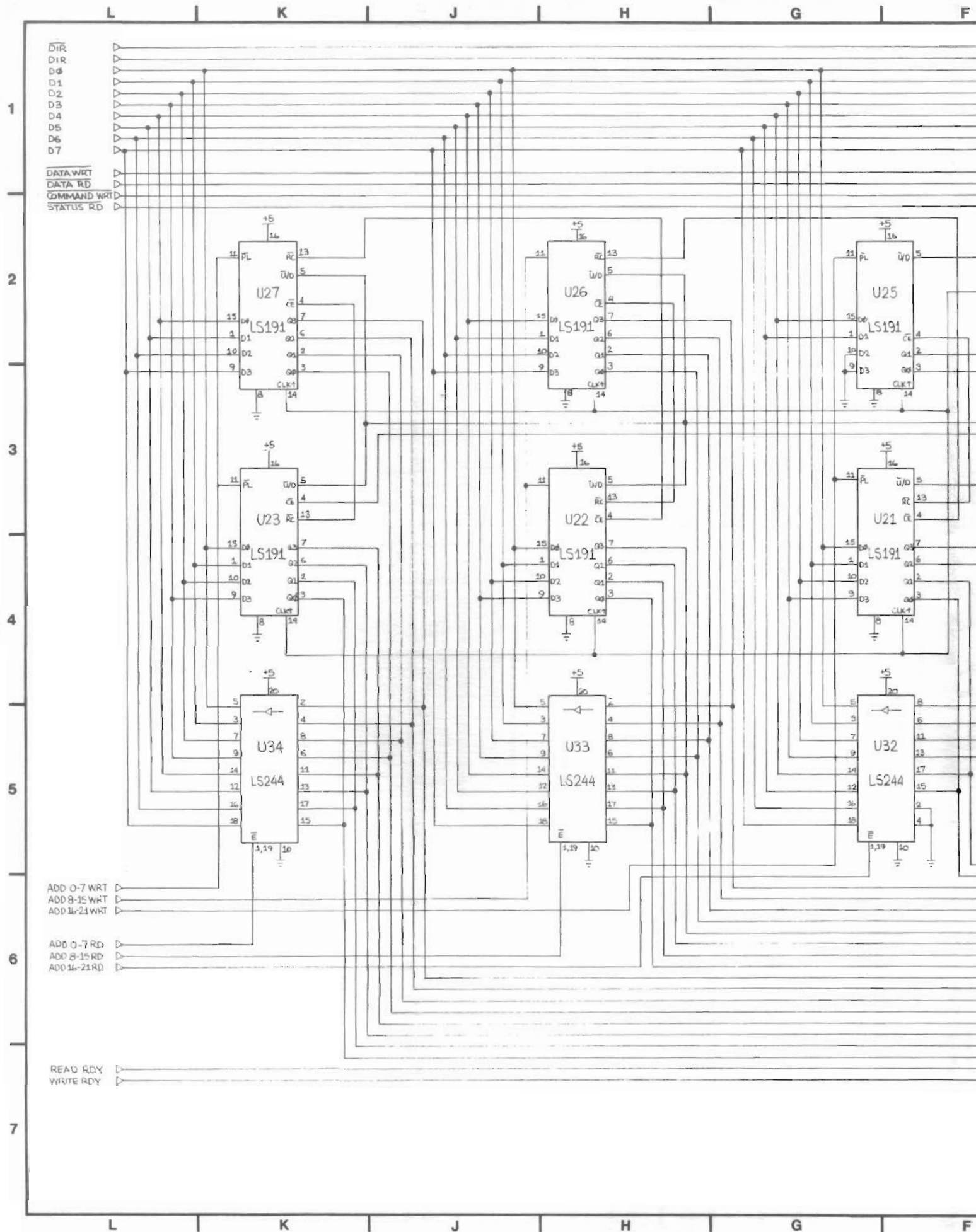

DIR  
 D18  
 D17  
 D16  
 D15  
 D14  
 D13  
 D12  
 D11  
 D10

DATA WRT  
 DATA RD  
 COMMAND WRT  
 STATUS RD

ADD 0-7 WRT  
 ADD 8-15 WRT  
 ADD 16-21 WRT

ADD 0-7 RD  
 ADD 8-15 RD  
 ADD 16-21 RD

READ RDY  
 WRITE RDY

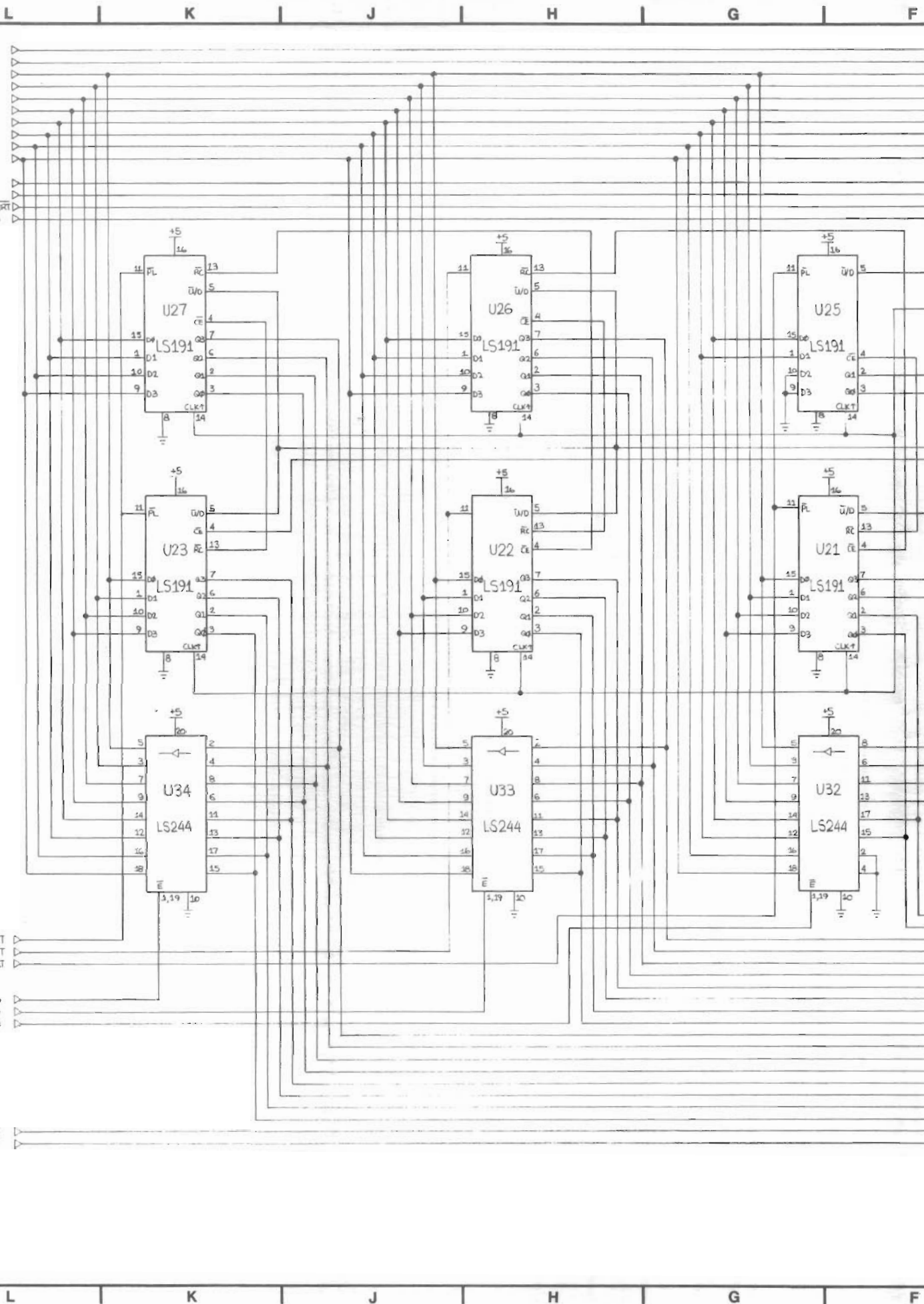

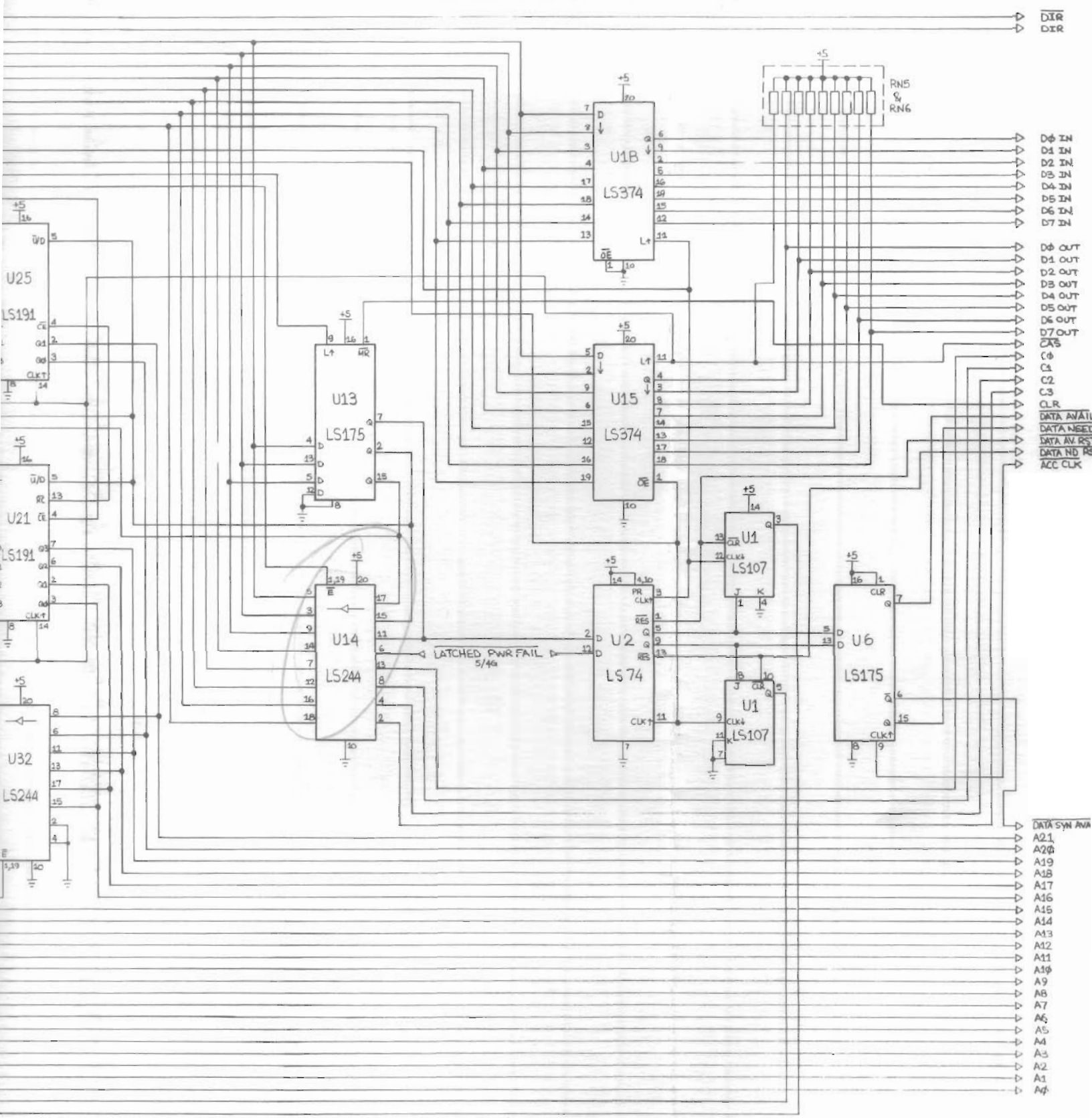

- DIR
- D7 IN
- D6 IN
- D5 IN
- D4 IN
- D3 IN
- D2 IN
- D1 IN
- D0 IN
- D7 OUT
- D6 OUT
- D5 OUT
- D4 OUT
- D3 OUT
- D2 OUT
- D1 OUT
- D0 OUT
- CS
- C2
- C3
- CLR
- DATA AVAIL
- DATA NEED
- DATA AV. RS
- DATA ND RS
- ACC CLK
- DATA SYN AVA
- A21
- A20
- A19
- A18
- A17
- A16
- A15
- A14
- A13
- A12
- A11
- A10
- A9
- A8
- A7
- A6
- A5
- A4
- A3
- A2
- A1
- A0

DO NOT SCALE TO DRAWING

REV	ZONE	DESCRIPTION	DATE	APPROVED
MODEL		QUASI-DISK	DWG DE-900006-00	
DESC		SEMICONDUCTOR DISK	REV-C00	
SCALE	NONE	SHT 2 OF 5	DWN BPZ	
CKD	APP RPH	DATE 11/07/83		